

• LINEA TETTO

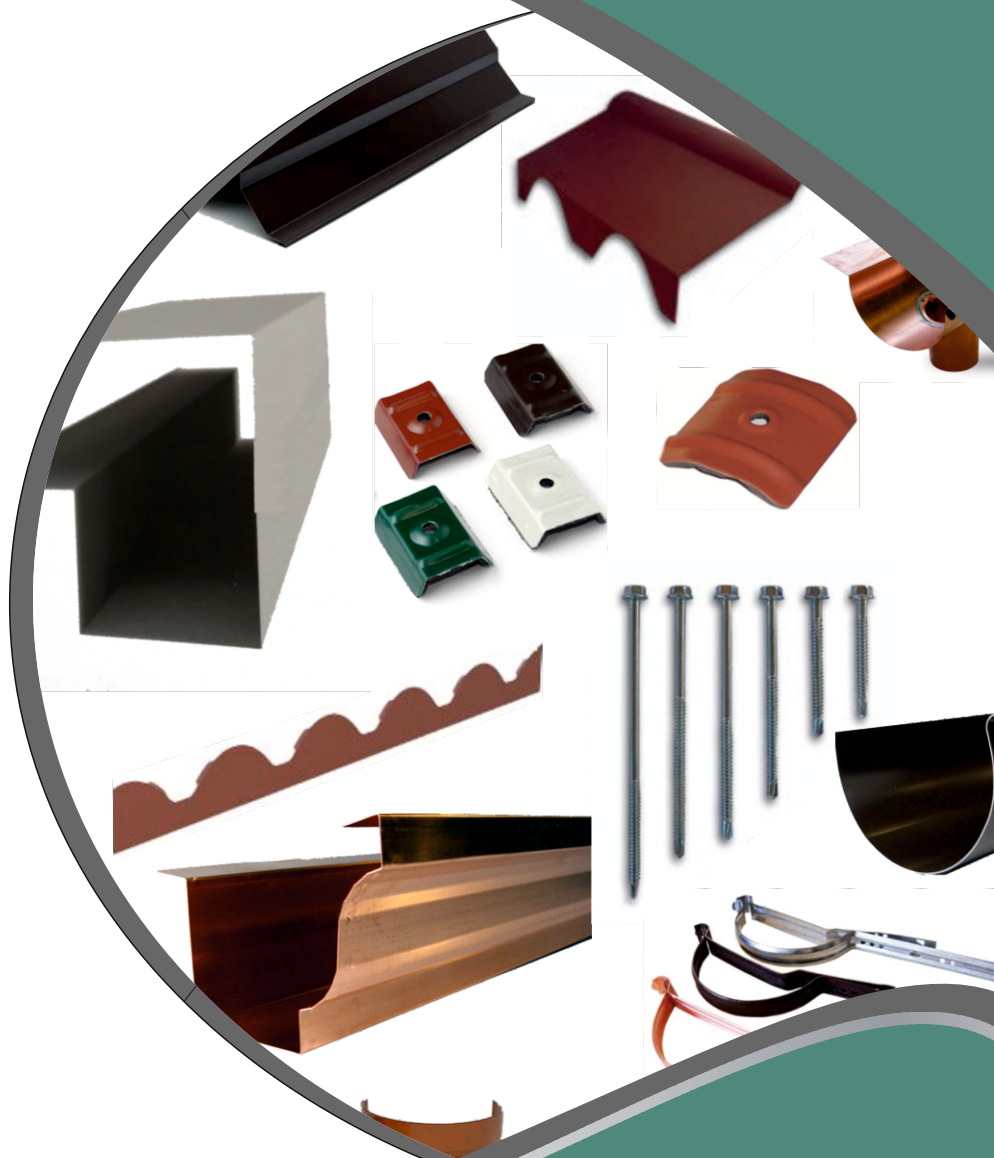

CAPPELLOTTO

COD.	DESCRIZIONE PRODOTTO	PZ./CF.
CAP4615	CAPPELLOTTO MIS. 46 X 15*	300
CAP4620	CAPPELLOTTO MIS. 46 X 20*	250
CAP4625	CAPPELLOTTO MIS. 46 X 25*	250
CAP4650	CAPPELLOTTO COPPO MIS. 46 X 50**	300

* *colori disponibili : terracotta, giallo antichizzato

**Disponibili rosso siena, bianco grigio e zincati



VITE FERRO AUTOPERFORANTE PER FERRO

COD.	DESCRIZIONE PRODOTTO	PZ./CF.
V6360	VITE ZINCATA AUTOPERF. MIS 6,3X60	100
V6370	VITE ZINCATA AUTOPERF. MIS 6,3X70	100
V6380	VITE ZINCATA AUTOPERF. MIS 6,3X80	100
V6390	VITE ZINCATA AUTOPERF. MIS 6,3X90	100
V63100	VITE ZINCATA AUTOPERF. MIS 6,3X100	100
V63110	VITE ZINCATA AUTOPERF. MIS 6,3X110	100
V63120	VITE ZINCATA AUTOPERF. MIS 6,3X120	100
V63130	VITE ZINCATA AUTOPERF. MIS 6,3X130	100
V63150	VITE ZINCATA AUTOPERF. MIS 6,3X150	100
V63180	VITE ZINCATA AUTOPERF. MIS 6,3X180	100
VE63200	VITE ZINCATA AUTOPERF. MIS 6,3X200	100



VITE LEGNO AUTOFILETTANTE PER LEGNO

COD.	DESCRIZIONE PRODOTTO	PZ./CF.
V6060	VITE ZINCATA AUTOFIL. MIS 6X60	100
V6070	VITE ZINCATA AUTOFIL. MIS 6X70	100
V6080	VITE ZINCATA AUTOFIL. MIS 6X80	100
V6090	VITE ZINCATA AUTOFIL. MIS 6X90	100
V60100	VITE ZINCATA AUTOFIL. MIS 6X100	100
V60110	VITE ZINCATA AUTOFIL. MIS 6X110	100
V60120	VITE ZINCATA AUTOFIL. MIS 6X120	100
V60130	VITE ZINCATA AUTOFIL. MIS 6X130	100
V60150	VITE ZINCATA AUTOFIL. MIS 6X150	100
V60180	VITE ZINCATA AUTOFIL. MIS 6X180	100
V60200	VITE ZINCATA AUTOFIL. MIS 6X200	100



SCOSSALINA E COLMO PER TERMOCOPERTURA

COD.	DESCRIZIONE PRODOTTO	PZ./CF.
RS1	COLMO ORIENTABILE mt 3,10 R/S	1
RS2	COLMO ORIENTABILE mt 1,10 R/S	1
RS3	SCOSSALINA FRONTALE mt 3,10 R/S	1
RS4	SCOSSALINA DI CODA CHIUSA mt 3,10 R/S	1
RS5	SCOSSALINA DI CODA APERTA mt 3,10 R/S	1
RS6	SCOSSALINA LATERALE CHIUSA mt 3,10 R/S	1

Disponibile per pannelli 4/5/6 greche col. R/S-B/G-TDM

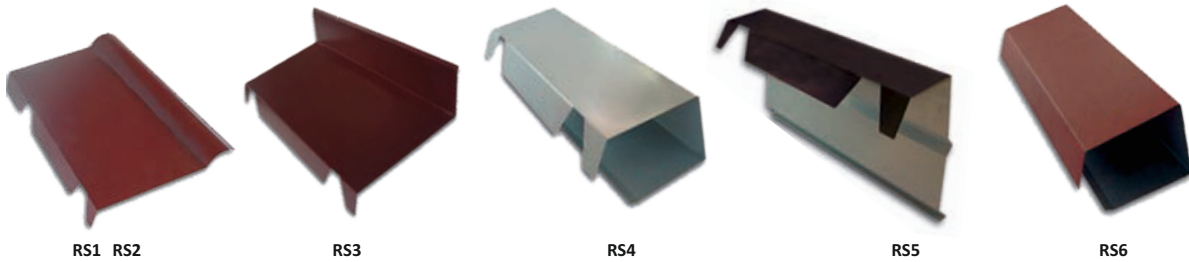

COLMO PER COPPO

COD.	DESCRIZIONE PRODOTTO	PZ./CF.
RS8	COLMO ORIENTABILE TIPO COPPO mt 3,10	40

colori disponibili : terracotta, giallo antichizzato

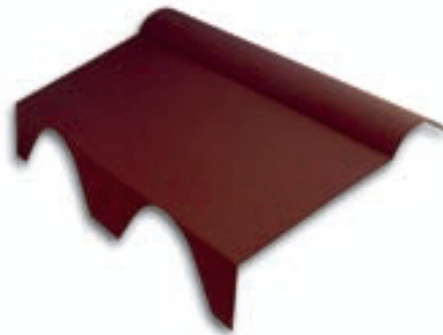

FRONTALINO / FRONTALINO PER COPPO

COD.	DESCRIZIONE PRODOTTO	PZ./CF.
RS7	FRONTALINO R/S*	40
RS9	FRONTALINO TIPO COPPO**	40

*Disponibile per pannelli 4/5/6 greche col. R/S-B/G-TDM

**colori disponibili : terracotta, giallo antichizzato

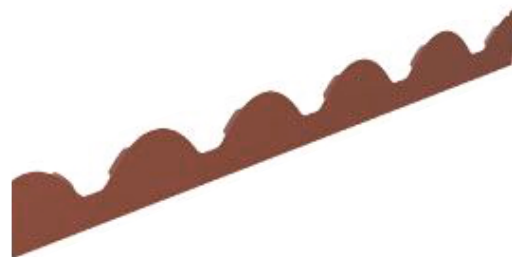

GRONDAIA TERMOCOPERTURA

COD.

DESCRIZIONE PRODOTTO

PZ./CF.

RS10 GRONDAIA PER TERMOCOPERTURA

RS11 TESTATE PER TERMOCOPERTURA SV. 500 DX & SX

Disponibile col. R/S-B/G-TDM

GRONDAIA TERMOCOPERTURA

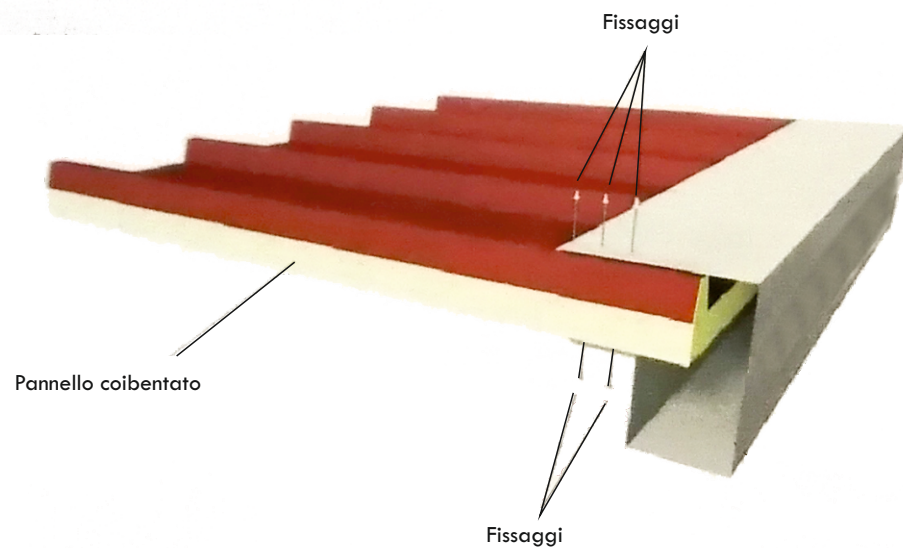
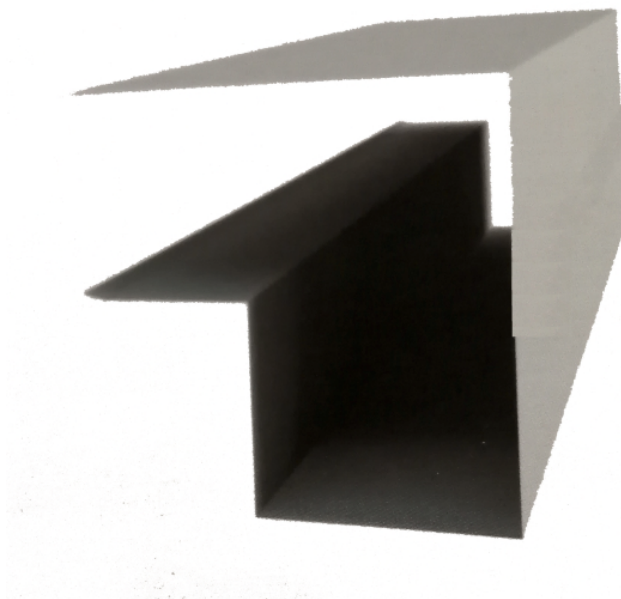
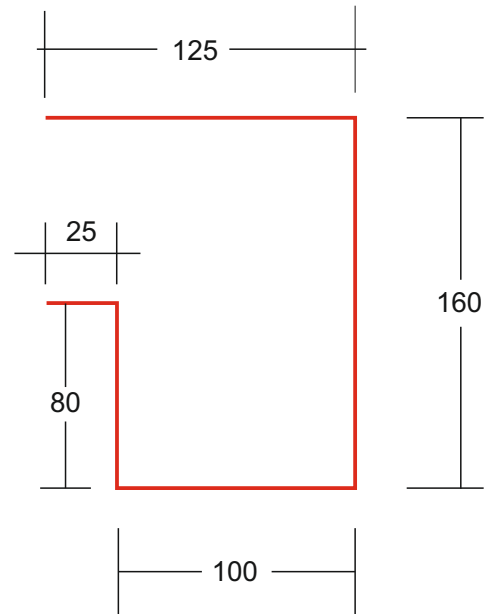

GRONDAIA

COD.	DESCRIZIONE PRODOTTO
GR1	GRONDAIA TDM SV. 330 SEMITONDA
GR2	GRONDAIA TDM SV. 381 GROVER
GR3	GRONDAIA TDM SV. 420
GR4	GRONDAIA TDM SV. 500
GR5	GRONDAIA LAM. RAME SV. 330 SEMITONDA
GR6	GRONDAIA LAM. RAME SV. 381 GROVER
GR7	GRONDAIA LAM. RAME SV. 420
GR8	GRONDAIA LAM. RAME SV. 500
GR9	GRONDAIA RAME SV. 330 SEMITONDA
GR10	GRONDAIA RAME SV. 381 GROVER
GR11	GRONDAIA RAME SV. 420
GR12	GRONDAIA RAME SV. 500

Disponibili anche in lamiera zincata, inox e alluminio (vari colori)
Lunghezze ml 3/4/5/6/7.

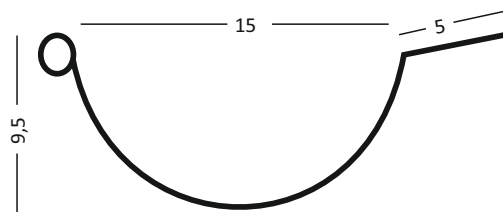

mod. SEMITONDA

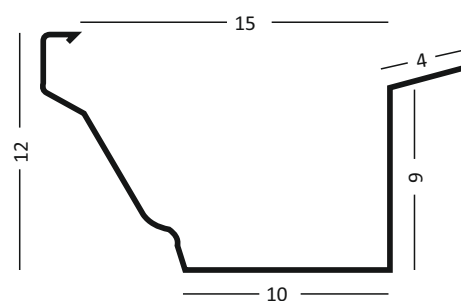

mod. GROVER

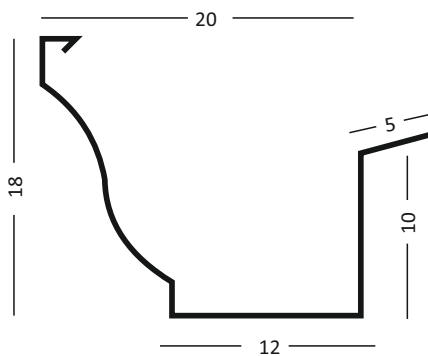

SV500 MOD. TOP 500

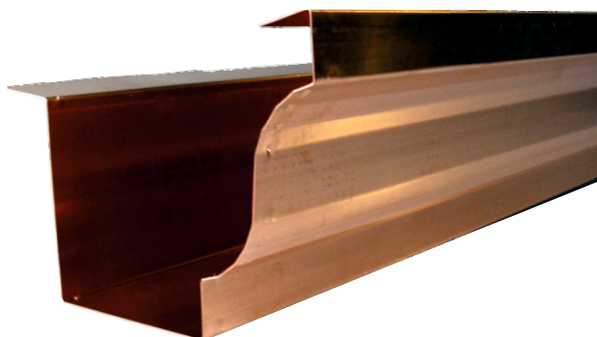

SCOSSALINA

COD.	DESCRIZIONE PRODOTTO
SC1	SCOSSALIA TDM SV 250
SC2	SCOSSALINA TDM SV 330
SC3	SCOSSALINA TDM SV 381
SC4	SCOSSALINA TDM SV 420
SC5	SCOSSALINA TDM SV 500
SC6	SCOSSALINA LAM. RAME SV. 250
SC7	SCOSSALINA LAM. RAME SV. 330
SC8	SCOSSALINA LAM. RAME SV. 381
SC9	SCOSSALINA LAM. RAME SV. 420
SC10	SCOSSALINA LAM. RAME SV. 500
SC11	SCOSSALINA RAME SV. 250
SC12	SCOSSALINA RAME SV. 330
SC13	SCOSSALINA RAME SV. 381
SC14	SCOSSALINA RAME SV. 420
SC15	SCOSSALINA RAME SV. 500

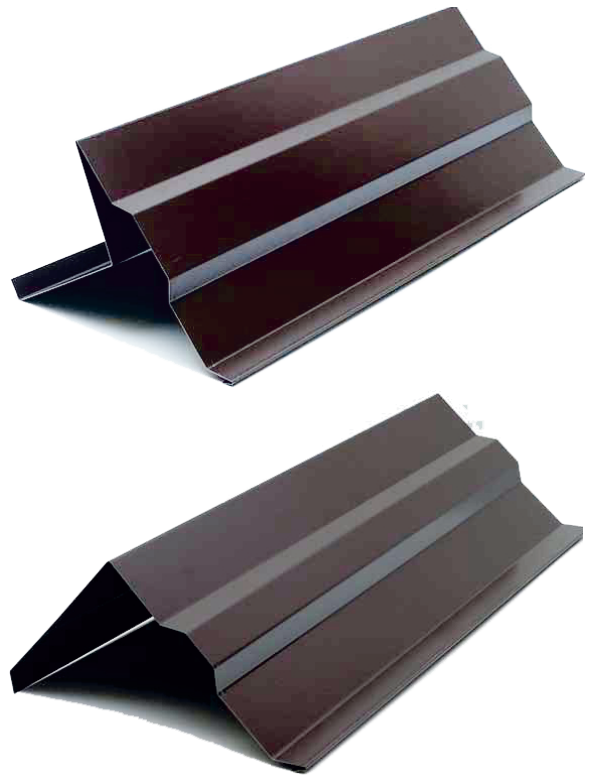

Disponibili anche in lamiera zincata, inox e alluminio (vari colori)
Lunghezze ml 3/4/5/6/7.

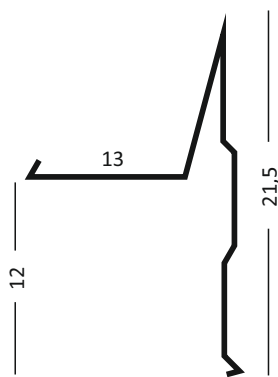

SV500 SOTTOTEGOLA

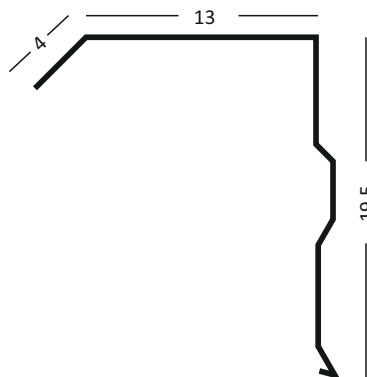

SV381 SOPRATEGOLA MOD. 1091

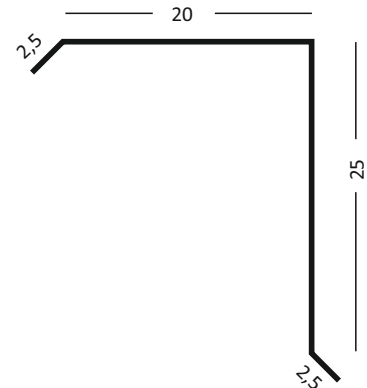

SV500 SOPRATEGOLA

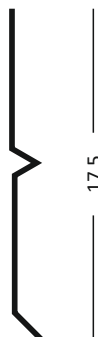

SV250 FRONTALINO

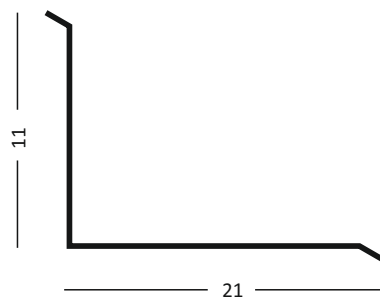

SV330 TETTO/MURO SOPRATEGOLA

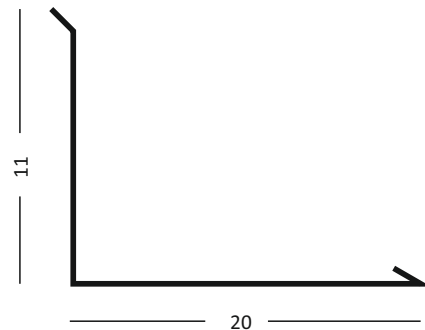

SV330 TETTO/MURO E SOTTOTEGOLA

STAFFA E TIRANTE PER GRONDA

COD.	DESCRIZIONE PRODOTTO	PZ./CF.
ST1	STAFFA DOPPIA TDM SV. 280 SEMITONDA	50
ST2	STAFFA TDM SV. 381 GROVER	50
ST2D	STAFFA DOPPIA TDM SV. 381 GROVER	50
ST3	STAFFA TDM SV. 420	50
ST4	STAFFA TDM SV. 500	100
ST5	STAFFA DOPPIA LAM. RAME SV. 280 SEMITONDA	50
ST6	STAFFA LAM. RAME SV. 381 GROVER	50
ST6D	STAFFA DOPPIA LAM. RAME SV. 381 GROVER	50
ST7	STAFFA LAM. RAME SV. 420	50
ST8	STAFFA LAM. RAME SV. 500	50
ST9	STAFFA DOPPIA RAME SV. 280 SEMITONDA	50
ST10	STAFFA RAME SV. 381 GROVER	50
ST11	STAFFA RAME SV. 420	50
ST12	STAFFA RAME SV. 500	50



ST1-ST9



ST4-ST8

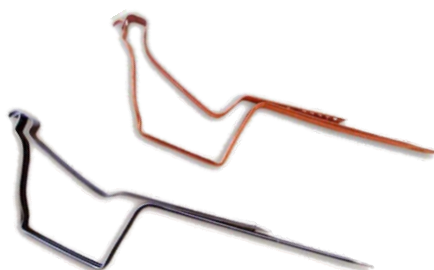

ST2D



ST2

STAFFA A MURO PER GRONDA

COD.	DESCRIZIONE PRODOTTO	PZ./CF.
ST1M	STAFFA TDM SV. 280 SEMIT. A MURO	50
ST5M	STAFFA LAM. RAME SV. 280 SEMIT. A MURO	50



TESTATA PER GRONDA

COD.	DESCRIZIONE PRODOTTO	PZ./CF.
TES1	TESTATA INCASTRO TDM SV. 280 SEMITONDA	50
TES2	TESTATA TDM SV. 381 GROVER DX & SX	50
TES3	TESTATA TDM SV. 420 DX & SX	50
TES4	TESTATA TDM SV. 500 DX & SX	50
TES5	TESTATA INCASTRO LAM. RAME SV. 280 SEMIT.	50
TES6	TESTATA LAM. RAME SV. 381 GROVER DX & SX	50
TES7	TESTATA LAM. RAME SV. 420 DX & SX	50
TES8	GRONDAIA LAM. RAME SV. 500	50
TES9	TESTATA INCASTRO RAME SV. 280 SEMIT.	50
TES10	TESTATA RAME SV. 381 GROVER DX & SX	50
TES11	TESTATA RAME SV. 420 DX & SX	50
TES12	TESTATA RAME SV. 500 DX & SX	50



mod. SEMITONDA



mod. SEMITONDA



mod. SV500



mod. GROVER

GIUNZIONE PER GRONDA

COD.	DESCRIZIONE PRODOTTO	PZ./CF.
GI1	GIUNZIONE INCASTRO TDM SV. 280 SEMITONDA	50
GI2	GIUNZIONE INCASTRO LAM. RAME SV. 280 SEMIT.	50
GI3	GIUNZIONE INCASTRO RAME SV. 280 SEMITONDA	50



GIUNZIONE PER GRONDA

COD.	DESCRIZIONE PRODOTTO	PZ./CF.
VAS1	VASCHETTA CON SCARICO TDM SV 28+5 D.80	25
VAS2	VASCHETTA CON SCARICO TDM SV 28+5 D.100	25
VAS3	VASCHETTA CON SCARICO LAM. RAME SV 28+5 D.80	25
VAS4	VASCHETTA CON SCARICO LAM. RAME SV 28+5 D.100	25
VAS5	VASCHETTA CON SCARICO RAME SV 28+5 D.80	25
VAS6	VASCHETTA CON SCARICO RAME SV 28+5 D.100	25



BOCCHETTA DI SCARICO PER GRONDA

COD.	DESCRIZIONE PRODOTTO	PZ./CF.
BOC1	BOCCHETTA SAGOMATA TDM D.80	100
BOC2	BOCCHETTA SAGOMATA TDM D.100	100
BOC3	BOCCHETTA PIANA TDM D.80	100
BOC4	BOCCHETTA PIANA TDM D.100	100
BOC5	BOCCHETTA PIANA LAM. RAME D.80	100
BOC6	BOCCHETTA PIANA LAM. RAME D.100	100
BOC7	BOCCHETTA SAGOMATA LAM. RAME D.80	100
BOC8	BOCCHETTA SAGOMATA LAM. RAME D.100	100
BOC9	BOCCHETTA SAGOMATA RAME D.80	100
BOC10	BOCCHETTA SAGOMATA RAME D.100	100
BOC11	BOCCHETTA PIANA RAME D.80	100
BOC12	BOCCHETTA PIANA RAME D.100	100
BOC13	BOCCHETTA PIANA LAMIERA B/G D.80	100
BOC14	BOCCHETTA PIANA LAMIERA B/G D.100	100
BOC15	BOCCHETTA PIANA LAMIERA 9010 D.80	100
BOC16	BOCCHETTA PIANA LAMIERA 9010 D.100	100
BOC17	BOCCHETTA SAGOMATA LAMIERA ZINCATA D.80	100
BOC18	BOCCHETTA SAGOMATA LAMIERA ZINCATA D.100	100



BOCCHETTA SVIZZERA PER GRONDA

COD.	DESCRIZIONE PRODOTTO	PZ./CF.
BOCSV1	BOCCHETTA SVIZZERA TDM SV 280 D.80	25
BOCSV2	BOCCHETTA SVIZZERA TDM SV 280 D.100	25
BOCSV3	BOCCHETTA SVIZZERA LAM. RAME SV 280 D.80	25
BOCSV4	BOCCHETTA SVIZZERA LAM. RAME SV 280 D.100	25
BOCSV5	BOCCHETTA SVIZZERA RAME SV 280 D.80	25
BOCSV6	BOCCHETTA SVIZZERA RAME SV 280 D.100	25



ANGOLARE PER GRONDA

COD.	DESCRIZIONE PRODOTTO	PZ./CF.
AN1	ANGOLARE EST.& INT. TDM SV. 330 SEMITONDA	1
AN2	ANGOLARE EST.& INT. TDM SV. 381 GROVER	1
AN3	ANGOLARE EST.& INT. TDM SV. 420	1
AN4	ANGOLARE EST.& INT. TDM SV. 500	1
AN5	ANGOLARE EST.& INT.LAM. RAME SV. 330 SEMITONDA	1
AN7	ANGOLARE EST.& INT. LAM. RAME SV. 381 GROVER	1
AN8	ANGOLARE EST.& INT. LAM. RAME SV. 420	1
AN9	ANGOLARE EST.& INT. LAM. RAME SV. 500	1
AN10	ANGOLARE EST.& INT. RAME SV. 330 SEMITONDA	1
AN11	ANGOLARE EST.& INT. RAME SV. 381 GROVER	1



PLUVIALE MT. 1.00 - 2.00 - 3.00

COD.	DESCRIZIONE PRODOTTO	PZ./CF.
PL1	PLUVIALE TDM D. 80	5
PL2	PLUVIALE TDM D.100	5
PL3	PLUVIALE LAMIERA COL. RAME D.80	5
PL4	PLUVIALE LAMIERA COL. RAME D.100	5
PL5	PLUVIALE RAME D.80	5
PL6	PLUVIALE RAME D.100	5
PL7	PLUVIALE LAMIERA COL. BIANCO /GRIGIO D.80	5
PL8	PLUVIALE LAMIERA COL. BIANCO/GRIGIO D.100	5
PL9	PLUVIALE LAMIERA D.80 RAL	5
PL10	PLUVIALE LAMIERA D.100 RAL	5
PL11	PLUVIALE ALLUMINIO D.80 RAL	5
PL12	PLUVIALE ALLUMINIO D.100 RAL	5
PL13	PLUVIALE LAMIERA ZINCATA D.80	5
PL14	PLUVIALE LAMIERA ZINCATA D.100	5

Disponibili anche in lamiera zincata,inox e alluminio(vari colori).
Lunghezze ml 1/2/3

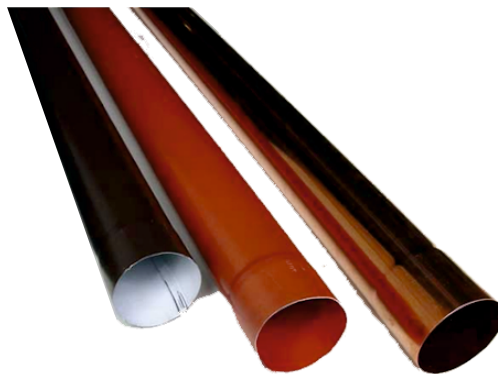

COLLARE PER PLUVIALE

COD.	DESCRIZIONE PRODOTTO	PZ./CF.
COL1	COLLARE LAMIERA TDM D.80 BLIST.2	100
COL2	COLLARE LAMIERA TDM D.100 BLIST.2	100
COL1Q	COLLARE LAMIERA TDM 80X80 BLIST.2	100
COL2Q	COLLARE LAMIERA TDM 100X100 BLIST.2	100
COL3	COLLARE LAMIERA RAME D.80 BLIST.2	100
COL4	COLLARE LAMIERA RAME D.100 BLIST.2	100
COL6	COLLARE RAME D.80 BLIST.2	100
COL7	COLLARE RAME D.100 BLIST.2	100
COL8	COLLARE LAMIERA B/G D.80 BLIST.2	100
COL9	COLLARE LAMIERA B/G D.100 BLIST.2	100
COL8B	COLLARE LAMIERA 9010 D.80 BLIST.2	100
COL9B	COLLARE LAMIERA 9010 D.100 BLIST.2	100
COL10	COLLARE ALLUMINIO D.80 BLIST.2 RAL.	100
COL11	COLLARE ALLUMINIO D.100 BLIST.2 RAL.	100
COL12	COLLARE ZINCATO D.40	100
COL13	COLLARE ZINCATO D.50	100
COL14	COLLARE ZINCATO D.60	100
COL15	COLLARE ZINCATO D.80 BLIST.2	100
COL16	COLLARE ZINCATO D.90	50
COL17	COLLARE ZINCATO D.100 BLIST.2	100
COL18	COLLARE ZINCATO D.110	50
COL19	COLLARE ZINCATO D.125	50
COL20	COLLARE ZINCATO D.140	50
COL21	COLLARE ZINCATO D.160	50
COL22	COLLARE ZINCATO D.200	50
COL23	COLLARE ZINCATO D.250	50
COL24	COLLARE PER TERMINALI GHISA D.80	50
COL25	COLLARE PER TERMINALI GHISA D.100	50
COL26	COLLARI ZINCATI D.80X110 PER TUBO TERRACOTTA	50
COL27	COLLARI ZINCATI D.100X125 PER TUBO TERRACOTTA	50



GOMITO PER PLUVIALE

COD.	DESCRIZIONE PRODOTTO	PZ./CF.
GOM1	GOMITO LAMIERA TDM F2 APERTI 72° D.80	10
GOM2	GOMITO LAMIERA TDM F3 CHIUSI 87° D.80	10
GOM3	GOMITO LAMIERA TDM F2 APERTI 72° D.100	10
GOM4	GOMITI LAMIERA TDM F3 CHIUSI 87° D.100	10
GOM5	GOMITI LAMIERA RAME F2 APERTI 72° D.80	10
GOM6	GOMITI LAMIERA RAME F3 CHIUSI 87° D.80	10
GOM7	GOMITI LAMIERA RAME F2 APERTI 72° D.100	10
GOM8	GOMITI LAMIERA RAME F3 CHIUSI 87° D.100	10
GOM9	GOMITI RAME F2 APERTI 72° D.80	10
GOM10	GOMITI RAME F3 CHIUSI 87° D.80	10
GOM11	GOMITI RAME F2 APERTI 72° D.100	10
GOM12	GOMITI RAME F3 CHIUSI 87° D.100	10
GOM13	GOMITI LAMIERA B/G F2 APERTI 72° D.80	10
GOM14	GOMITI LAMIERA B/G F3 CHIUSI 87° D.80	10
GOM15	GOMITI LAMIERA B/G F2 APERTI 72° D.100	10
GOM16	GOMITI LAMIERA B/G F3 CHIUSI 87° D.100	10
GOM17	GOMITI LAMIERA 9010 F2 APERTI 72° D.80	10
GOM18	GOMITI LAMIERA 9010 F3 CHIUSI 87° D.80	10
GOM19	GOMITI LAMIERA 9010 F2 APERTI 72° D.100	10
GOM20	GOMITI LAMIERA 9010 F3 CHIUSI 87° D.100	10
GOM21RAL	GOMITI ALLUMINIO F2 APERTI 72° D.80 RAL	10
GOM22RAL	GOMITI ALLUMINIO F3 CHIUSI 87° D.80 RAL	10
GOM23RAL	GOMITI ALLUMINIO F2 APERTI 72° D.100 RAL	10
GOM24RAL	GOMITI ALLUMINIO F3 CHIUSI 87° D.100 RAL	10
GOM31	GOMITI ZINCATI F2 APERTI 72° D.80	10
GOM32	GOMITI ZINCATI F3 CHIUSI 87° D.80	10
GOM33	GOMITI ZINCATI F2 APERTI 72° D.100	10
GOM34	GOMITI ZINCATI F3 CHIUSI 87° D.100	10



Disponibili anche in lamiera zincata,inox e alluminio(vari colori).

ACCESSORI LATTONERIA

BRAGA PER PLUVIALE

COD.	DESCRIZIONE PRODOTTO	PZ./CF.
BRA1	BRAGA TDM D.80	6
BRA2	BRAGA TDM D.100	6
BRA3	BRAGA LAM. RAME D.80	6
BRA4	BRAGA LAM. RAME D.100	6
BRA5	BRAGA RAME D.80	6
BRA6	BRAGA RAME D.100	6
BRA7	BRAGHE LAM. B/G D.80	6
BRA8	BRAGHE LAM. B/G D.100	6
BRA9	BRAGHE LAM. 9010 D.80	6
BRA10	BRAGHE LAM. 9010 D.100	6
BRA11RAL	BRAGHE ALLUMINIO D.80 RAL	6
BRA12RAL	BRAGHE ALLUMINIO D.100 RAL	6

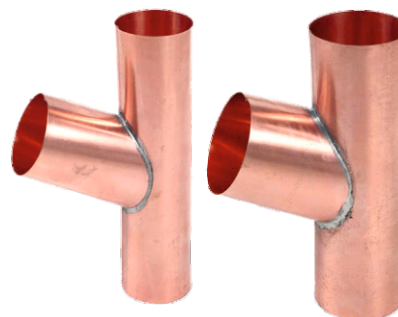

Disponibili anche in lamiera zincata,inox e alluminio(vari colori).

BICCHIERE PER PLUVIALE

COD.	DESCRIZIONE PRODOTTO	PZ./CF.
BIC1	BICCHIERE DI GIUNZIONE TDM D.80	10
BIC2	BICCHIERE DI GIUNZIONE TDM D.100	10
BIC3	BICCHIERE DI GIUNZIONE LAM. RAME D.80	10
BIC4	BICCHIERE DI GIUNZIONE LAM. RAME D.100	10
BIC5	BICCHIERE DI GIUNZIONE RAME D.80	10
BIC6	BICCHIERE DI GIUNZIONE RAME D.100	10



GOMITO ALLUNGABILE PER PLUVIALE

COD.	DESCRIZIONE PRODOTTO	PZ./CF.
GOAL1	GOMITO ALLUNGABILE TDM 80X330	10
GOAL2	GOMITO ALLUNGABILE TDM 80X500	10
GOAL3	GOMITO ALLUNGABILE TDM 80X800	10
GOAL4	GOMITO ALLUNGABILE TDM 100X330	10
GOAL5	GOMITO ALLUNGABILE TDM 100X500	10
GOAL6	GOMITO ALLUNGABILE TDM 100X800	10
GOAL7	GOMITO ALLUNGABILE LAM. RAME 80X330	10
GOAL8	GOMITO ALLUNGABILE LAM. RAME 80X500	10
GOAL9	GOMITO ALLUNGABILE LAM. RAME 80X800	10
GOAL10	GOMITO ALLUNGABILE LAM. RAME 100X330	10
GOAL11	GOMITO ALLUNGABILE LAM. RAME 100X500	10
GOAL12	GOMITO ALLUNGABILE LAM. RAME 100X800	10
GOAL13	GOMITO ALLUNGABILE RAME 80X330	10
GOAL14	GOMITO ALLUNGABILE RAME 80X500	10
GOAL15	GOMITO ALLUNGABILE RAME 80X800	10
GOAL16	GOMITO ALLUNGABILE RAME 100X330	10
GOAL17	GOMITO ALLUNGABILE RAME 100X500	10
GOAL18	GOMITO ALLUNGABILE RAME 100X800	10



IMBUTO PER PLUVIALE

COD.	DESCRIZIONE PRODOTTO	PZ./CF.
IMB1	IMBUTO MOD. PALERMO TDM D.80	5
IMB2	IMBUTO MOD. PALERMO TDM D.100	5
IMB3	IMBUTO MOD. PALERMO LAM. RAME D.80	5
IMB4	IMBUTO MOD. PALERMO LAM. RAME D.100	5
IMB5	IMBUTO MOD. PALERMO RAME D.80	5
IMB6	IMBUTO MOD. PALERMO RAME D.100	5
IMB7	IMBUTI MOD. PALERMO LAM. B/G D.80	5
IMB8	IMBUTI MOD. PALERMO LAM. B/G D.100	5
IMB9	IMBUTI MOD. PALERMO LAM. 9010 D.80	5
IMB10	IMBUTI MOD. PALERMO LAM. 9010 D.100	5
IMB11RAL	IMBUTI MOD. PALERMO ALLUMINIO D.80 RAL.	5
IMB12RAL	IMBUTI MOD. PALERMO ALLUMINIO D.100 RAL.	5



Disponibili anche in lamiera zincata, inox e alluminio (vari colori).

RIDUZIONE/AUMENTO PER PLUVIALE

COD.	DESCRIZIONE PRODOTTO	PZ./CF.
RA1	RIDUZIONE / AUMENTO TDM 100/80	10
RA2	RIDUZIONE / AUMENTO LAM. RAME 100/80	10
RA3	RIDUZIONE / AUMENTO RAME 100/80	10



TRAVASATORE PER PLUVIALE

COD.	DESCRIZIONE PRODOTTO	PZ./CF.
TR1	TRAVASATORE TDM D.80	10
TR2	TRAVASATORE TDM D.100	10
TR3	TRAVASATORE RAME D.80	10
TR4	TRAVASATORE RAME D.100	10



SPOSTAMENTO PER PLUVIALE

COD.	DESCRIZIONE PRODOTTO	PZ./CF.
SP1	SPOSTAMENTO TDM D.80	10
SP2	SPOSTAMENTO TDM D.100	10
SP3	SPOSTAMENTO RAME D.80	10
SP4	SPOSTAMENTO RAME D.100	10



SPARGI ACQUA PER PLUVIALE

COD.	DESCRIZIONE PRODOTTO	PZ./CF.
SPA1	BOCCHETTA SPARGI ACQUA TDM D. 80	5
SPA2	BOCCHETTA SPARGI ACQUA TDM D. 100	5
SPA3	BOCCHETTA SPARGI ACQUA LAM. RAME D. 80	5
SPA4	BOCCHETTA SPARGI ACQUA LAM. RAME D. 100	5



TERMINALE PER PLUVIALE

COD.	DESCRIZIONE PRODOTTO	PZ./CF.
TER1	TERMINALE TDM D.80X2000 CON CURVA	5
TER2	TERMINALE TDM D.100X2000 CON CURVA	5
TER3	TERMINALE MINI TDM D.80X250 CON CURVA	5
TER4	TERMINALE MINI TDM D.100X250 CON CURVA	5
TER5	TERMINALE RAME D.80X1500 CON CURVA	5
TER6	TERMINALE RAME D.100X1500 CON CURVA	5
TER7	TERMINALE MINI RAME D.80X250 CON CURVA	5
TER8	TERMINALE MINI RAME D.100X250 CON CURVA	5
TER9	TERMINALE GHISA D.80X200 CON CURVA	1
TER10	TERMINALE GHISA D.100X200 CON CURVA	1
TER11	TERMINALE GHISA D.80X200 DIRITTO	1
TER12	TERMINALE GHISA D.100X200 DIRITTO	1



BORCHIE RIVETTI E TASSELLI

COD.	DESCRIZIONE PRODOTTO	PZ./CF.
AC1	BORCHIE TDM	100
AC2	BORCHIE LAM. RAME	100
AC3	BORCHIE RAME	100
AC4	RIVETTI ALL. COL TDM - RAL 9010	100
AC5	RIVETTI ALL. LAM. RAME	100*
AC5	RIVETTI RAME	100
AC6	TASSELLO A BATTERE TDM 6 X 40	200
AC7	TASSELLO A BATTERE TDM 6 X 60	100
AC8	TASSELLO ZAMAK 6 X 65	100

*Disponibili TDM 9010



SILICONE E ATTREZZI

COD.	DESCRIZIONE PRODOTTO	PZ./CF.
SOU05	SIGILLANTE TDM	24
SOU-05	SIGILLANTE RAME	24
AC10	BICCHIERATRICE D.80	1
AC11	BICCHIERATRICE D.100	1
AC12	SEGA A TAZZA D.80	1
AC13	SEGA A TAZZA D.100	1
AC14	ALBERO PER SEGA A TAZZA	1
AC15	VERNICE SPRAY TDM/BG/RS	12
AC16	VERNICE SPRAY RAME	12



FERMACOPPO

COD.	DESCRIZIONE PRODOTTO	PZ./CF.
FC1	FERMACOPPO TDM	500
FC2	FERMACOPPO TDM PRIMAFILA	250
FC3	FERMACOPPO RAME	500
FC4	FERMACOPPO RAME PRIMAFILA	250



TELO SOTTOTEGOLA

COD.	DESCRIZIONE PRODOTTO	MQ./CF.
TELO1	TELO TRASPIRANTE GR.140	75
TEL2	BARRIERA VAPORE GR.140	75



FINESTRA

COD.	DESCRIZIONE PRODOTTO	PZ./CF.
FINESTRA4555	FINESTRA BEST FORO CM 45X55 VETRO 4/9/4	1
FINESTRA4872	FINESTRA BEST FORO CM 48X72 VETRO 4/9/4	1

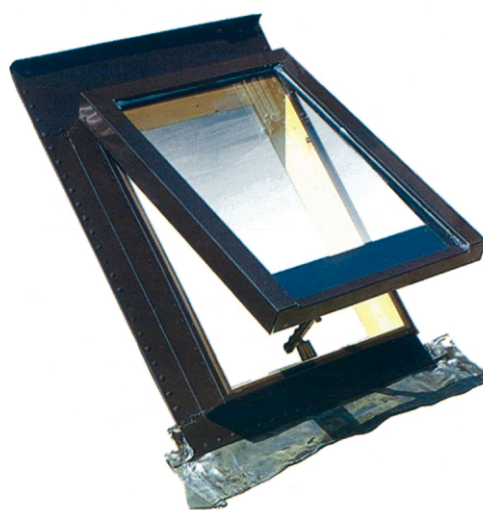

GRONDA ETRURIA 173

COD.	DESCRIZIONE PRODOTTO	PZ./CF.
ETRC1	CANALE DI GRONDA mt 3	26
ETRC2	CANALE DI GRONDA mt 4	26
ETRC3	CANALE DI GRONDA mt 5	26
ETRC4	CANALE DI GRONDA mt 6	26
ETRC5	CICOGNA DOPPIA ZINCATA E VERNICIATA	50
ETRC6	BOCCELLO D.80	20
ETRC7	BOCCELLO D.100	20
ETRC8	GIUNZIONE SENZA SCARICO c/guarn.	20
ETRC9	GIUNZIONE CON SCARICO c/guarn.	20
ETRC10	TESTATA SENZA SCARICO c/guarn.	20
ETRC11	TESTATA CON SCARICO c/guarn.	20
ETRC12	ANGOLARE SENZA SCARICO c/guarn.	20
ETRC13	ANGOLARE CON SCARICO c/guarn.	20
ETRC14	CICOGNA A MURO	50

COLORI DISPONIBILI RAME E MARRONE

ETRURIA 173 RAME



ETRURIA 173 MARRONE

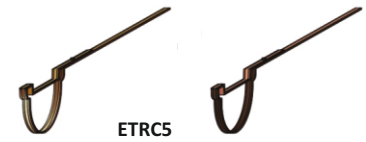
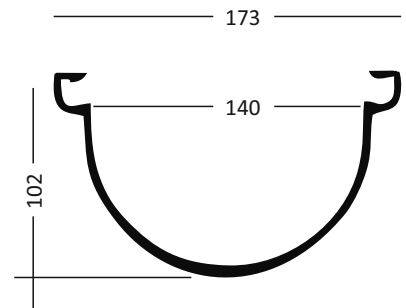
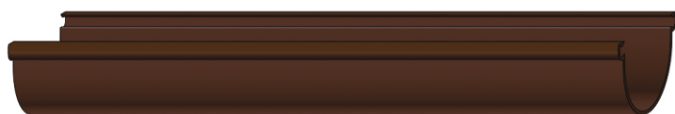

ETRC5



ETRC14



ETRC9



ETRC13



ETRC12



ETRC10



ETRC11



ETRC8



ETRC7



ETRC6

TUBO ETRURIA 173

COD.	DESCRIZIONE PRODOTTO	PZ./CF.
ETRT1	TUBO D. 80 mt. 1,07	2
ETRT2	TUBO D. 80 mt. 2,07	2
ETRT3	TUBO D. 80 mt. 3,07	2
ETRT4	TUBO D. 100 mt. 1,07	2
ETRT5	TUBO D. 100 mt. 2,07	2
ETRT6	TUBO D. 100 mt. 3,07	2
ETRT7	BRAGA 67° D. 80	20
ETRT8	BRAGA 67° D. 100	10
ETRT9	CURVA 67° D. 80	20
ETRT10	CURVA 67° D. 100	20
ETRT11	CURVA 87° D. 80	20
ETRT12	CURVA 87° D. 100	20

COLORI DISPONIBILI RAME , MARRONE E BIANCO

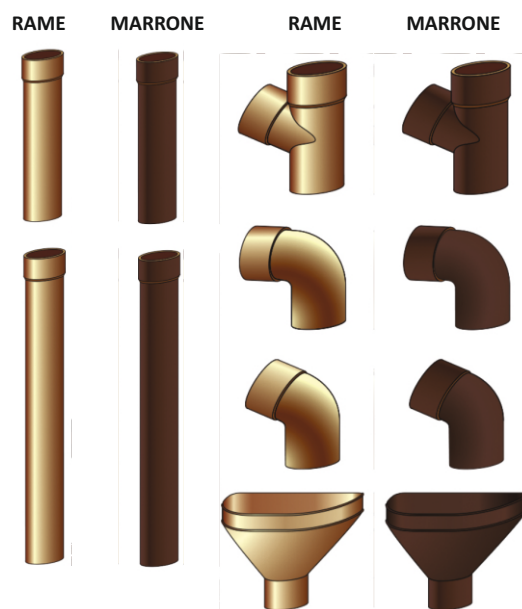

TUBO ETRURIA

TUBO PVC MARRONE QUADRO mt. 1-2-3

COD.	DESCRIZIONE PRODOTTO	Ø	PZ./CF.
ETRTQ80	TUBO IN PVC MARRONE	80X80	1
ETRTQ100	TUBO IN PVC MARRONE	100X100	1

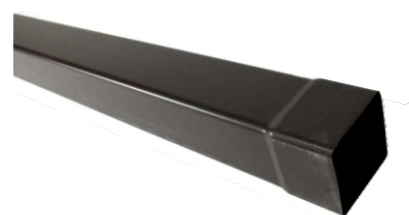

PEDONALE PVC ANTIURTO

COD.	DESCRIZIONE PRODOTTO	PZ./CF.
ETRT13	PEDONALE TONDO PVC CON CURVA D.80 mt. 2,13 NERO	5
ETRT14	PEDONALE TONDO PVC CON CURVA D.100 mt. 2,13 NERO	5



LASTRA IMAC GRECOLINA

COD.	DESCRIZIONE PRODOTTO	PZ./CF.
ETRL1	GRECOLINA LASTRA GRECATA IN ECOTRES	50
ETRL2	CAPPELLOTTO GRECAFIX	100

Passo 143 mm - spessore 19 mm
 Larghezza lastre 1060 mm
 Lunghezza lastre 2.000-3000-4000-5000-6000
 Superficie lucida
 Colori : terra cotta-rosso siena-grigio-verde



LASTRA IMAC "I COPPO VENEZIA"

COD.	DESCRIZIONE PRODOTTO	PZ./CF.
ETRL3	LASTRA I COPPO VENEZIA	50
ETRL4	CAPPELLOTTO ECOLFIX	100

Larghezza lastre 990 mm
 Lunghezza lastre 2.090
 Superficie semilucida
 Colore : terra cotta



LASTRE IN PLASTICA

COD.	DESCRIZIONE PRODOTTO	PZ./CF.
GUTTATUIL	GUTTATUIL EVO NERO 2,00X1,055	150
GUTTAPRAL-N	GUTTAPRAL NC EVO NERO 2,00X0,95	150
GUTTAPRAL-R	GUTTAPRAL NC EVO ROSSO 2,00X0,95	150
GUTTAPRAL-V	GUTTAPRAL NC EVO VERDE 2,00X0,95	150

gutta®

Lastre in plastica per la copertura definitiva

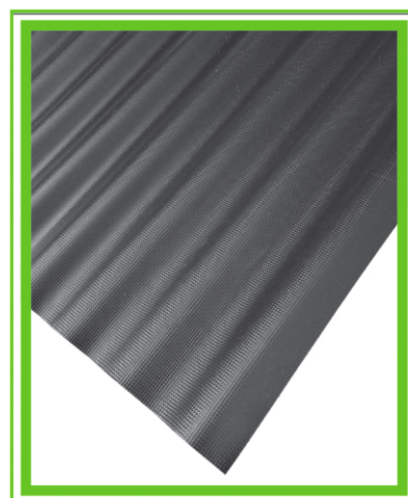
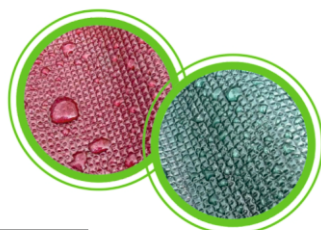

LASTRE GUTTA

Dati tecnici - GUTTA PRAL

Colori	Rosso, Verde e Nero
Dimensioni	2.00 x 0.95 mt.
Spessore	3 mm
Passo d'onda x altezza onda	95 x 34 mm
N° onde	10
Peso medio	3.35 kg./mq.
Superficie lorda	1.90 mq.
Superficie netta	1.59 mq.
Chiodatura	Vedi istruzioni di posa
Classe di resistenza al fuoco	E
Tolleranze	+ - 7%
Imballo	150 lastre per bancale

gutta®

Lastre in plastica per la posa di coppi 21-23 cm



Dati tecnici - GUTTA UIL

Dimensioni	2.00 x 1.055 mt.
Spessore	3 mm
Passo d'onda x altezza onda	96 x 32 mm
N° onde	9+4 parti piane
Peso medio	3.35 kg./mq.
Superficie lorda	2.11 mq.
Superficie netta	1.80 mq.
Chiodatura	Vedi istruzioni di posa
Classe di resistenza al fuoco	E
Tolleranze	+ - 7%
Imballo	150 lastre per bancale